

# OS-150

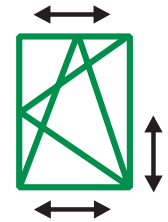
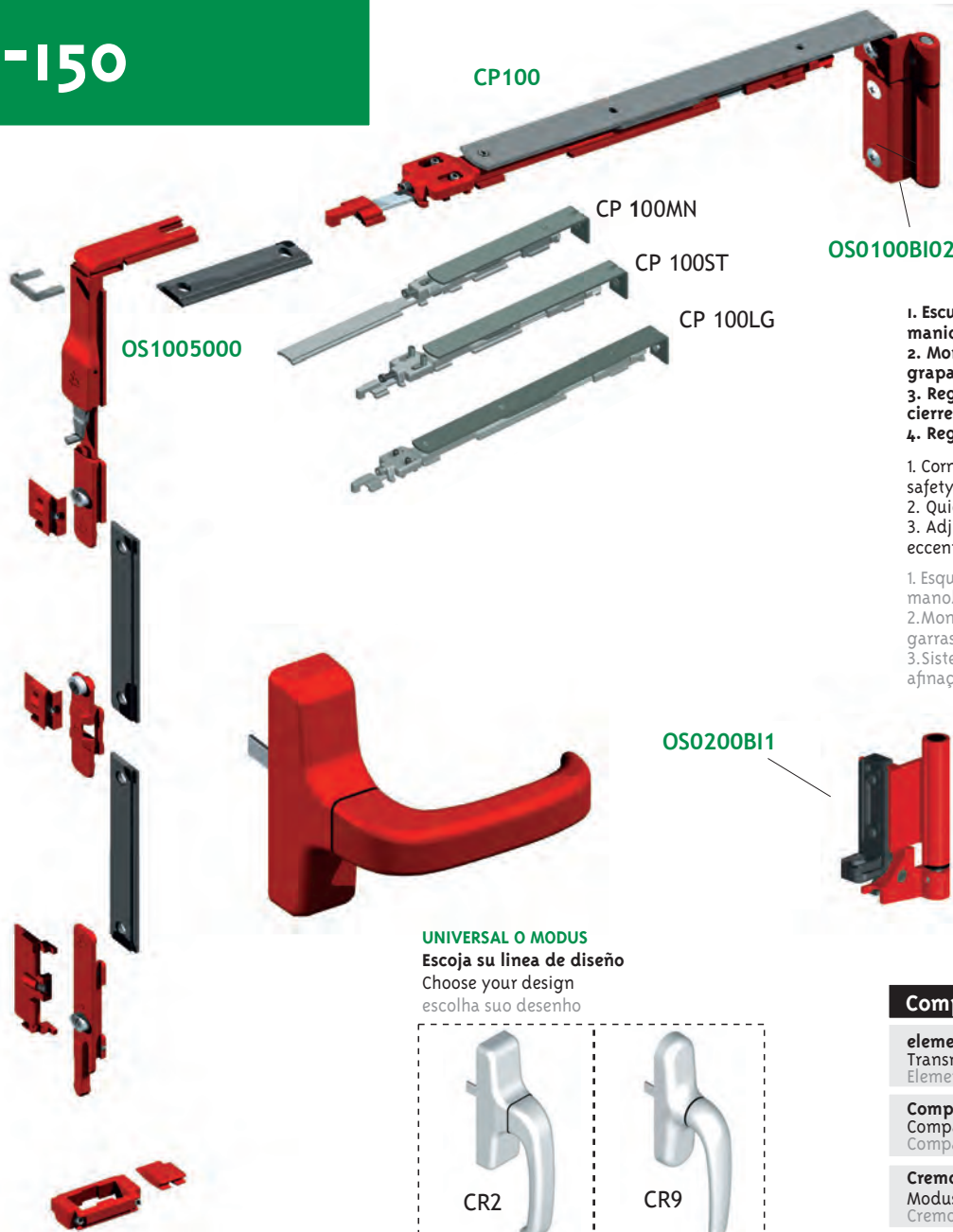

1. Escuadra de reenvío con antifalsa maniobra dcha. e izda.
2. Montaje ultrarápido mediante grapas.
3. Regulación de la presión de cierre mediante excéntricas.
4. Regulación horizontal en bisagras.

1. Corner Transmission with automatic safety device left and right.
2. Quick assembly with clip system.
3. Adjust the closing pressure with eccentric closing pawl.

1. Esquadro de reenvio com anti-falsa manobra automática dta. e esq.
2. Montagem do mecanismo com garras para montagem ultrarrápido.
3. Sistema regulador excêntrico de afinação de fecho.

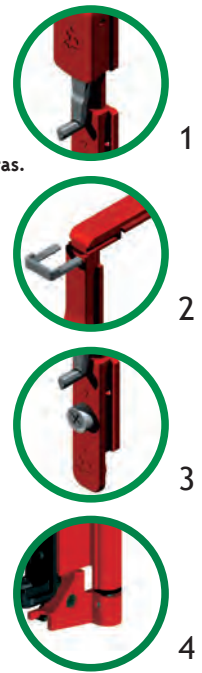

**UNIVERSAL O MODUS**  
Escoja su línea de diseño  
Choose your design  
escolha seu desenho

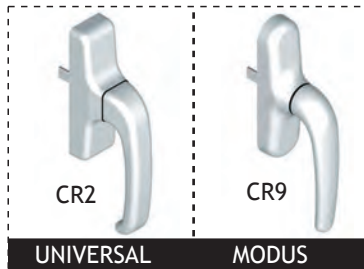

### Componentes-Components-Componentes

**elementos de transmisión con tercer punto de cierre**  
Transmission elements with third closing point  
Elementos de transmissão com tercer punto de fecho

**Compás MN, ST o LG**  
Compass MN, ST or LG  
Compasso MN, ST o LG

**Cremona Modus o Universal.**  
Modus or Universal handle  
Cremona Modus o Universal

## Specifications- Especificações

### Aplicaciones - Applications - Aplicações

Sistema para carpinterías de cámara europea. Sus elementos reversibles permiten su aplicación en ventanas de apertura derecha o izquierda.

This system has been designed for European Chamber aluminium carpentries and can be used for right or left opening.

Desenhada para series de Câmara Européia, permite abertura a direita e esquerda.

### Características - Features - Caraterísticas

5 puntos de cierre, incluido el cerradero central. Montaje ultrarrápido mediante grapas. Escuadras de reenvío con antifalsa maniobra derecha e izquierda. Regulación horizontal total de 3 mm.

Five points of closing, including and additional closing pawl in the handle. Quick assembly with clip system. Center transmission with automatic safety device left and right.

5 pontos de fecho, inclui o fecho central. Montagem ultrarrápido mediante garras. Escudro reenvio com antifalsa manobra automática dta. e esq.

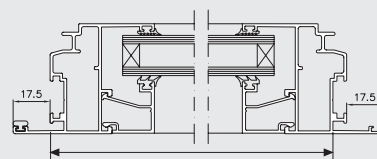
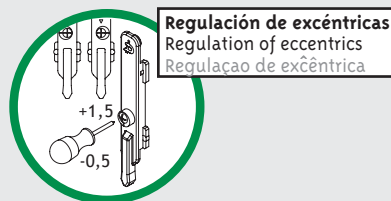
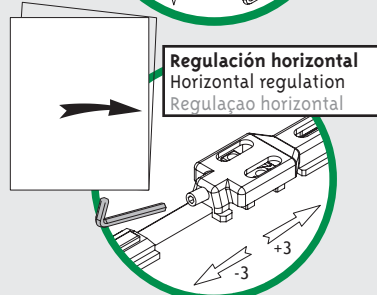
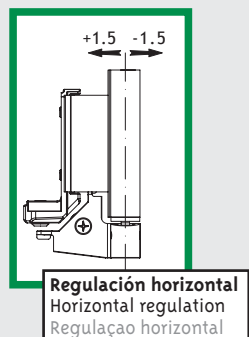
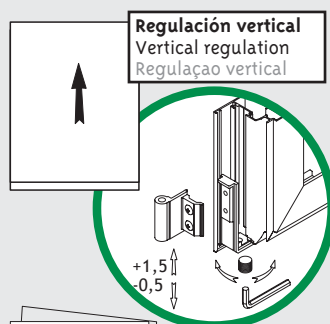

Mmin.

**Medidas mínimas de hoja**  
Minimum measures of leaf  
Medidas mínimas da folha

OS150 P10-MN7 Mmin. 270 mm.  
OS150P 10-ST7 Mmin. 380 mm.  
OS150P10-LG7 Mmin. 550 mm.

**RAL TEST**  
80 Kg.  
15000 ciclos  
movimiento

| altura<br>height<br>altura | 25 | 37 | 27 | 22 | 18 | 14 | 12 | 11 | 10 | 9  | 8  | 8  | 7  | 7  | 6  | 6  |
|----------------------------|----|----|----|----|----|----|----|----|----|----|----|----|----|----|----|----|
| 2800                       | 57 | 38 | 28 | 23 | 19 | 14 | 13 | 11 | 10 | 9  | 8  | 8  | 7  | 7  | 6  | 6  |
| 2700                       | 59 | 39 | 30 | 24 | 20 | 17 | 13 | 12 | 11 | 10 | 9  | 8  | 8  | 7  | 7  | 6  |
| 2600                       | 41 | 31 | 25 | 21 | 18 | 14 | 12 | 11 | 10 | 9  | 8  | 8  | 7  | 7  | 6  | 6  |
| 2500                       | 43 | 32 | 26 | 21 | 18 | 15 | 13 | 12 | 11 | 10 | 9  | 9  | 8  | 8  | 7  | 7  |
| 2400                       | 45 | 33 | 27 | 22 | 19 | 17 | 13 | 12 | 11 | 10 | 10 | 9  | 8  | 8  | 7  | 7  |
| 2300                       | 47 | 35 | 28 | 23 | 20 | 17 | 14 | 13 | 12 | 11 | 10 | 9  | 9  | 8  | 8  | 7  |
| 2200                       | 49 | 37 | 29 | 24 | 21 | 18 | 15 | 13 | 12 | 11 | 10 | 10 | 9  | 9  | 8  | 8  |
| 2100                       | 51 | 38 | 31 | 26 | 22 | 19 | 17 | 14 | 13 | 12 | 11 | 10 | 10 | 9  | 9  | 8  |
| 2000                       | 54 | 40 | 32 | 27 | 23 | 20 | 18 | 16 | 15 | 13 | 12 | 12 | 11 | 10 | 10 | 9  |
| 1900                       | 57 | 43 | 34 | 28 | 24 | 21 | 19 | 17 | 14 | 13 | 12 | 11 | 11 | 10 | 10 | 9  |
| 1800                       | 45 | 36 | 30 | 26 | 23 | 20 | 18 | 16 | 15 | 14 | 13 | 12 | 11 | 11 | 10 | 9  |
| 1700                       | 48 | 38 | 32 | 27 | 24 | 21 | 19 | 17 | 15 | 14 | 13 | 12 | 11 | 11 | 10 | 9  |
| 1600                       | 51 | 41 | 34 | 29 | 26 | 23 | 21 | 19 | 17 | 16 | 15 | 14 | 13 | 12 | 12 | 10 |
| 1500                       | 55 | 44 | 37 | 31 | 27 | 24 | 22 | 20 | 18 | 17 | 16 | 15 | 14 | 13 | 12 | 10 |
| 1400                       | 59 | 47 | 39 | 34 | 30 | 26 | 24 | 22 | 20 | 19 | 17 | 16 | 15 | 13 | 12 | 10 |
| 1300                       | 51 | 43 | 37 | 32 | 28 | 26 | 23 | 21 | 20 | 17 | 15 | 14 | 13 | 12 | 10 | 10 |
| 1200                       | 56 | 47 | 40 | 35 | 31 | 28 | 25 | 23 | 20 | 17 | 15 | 14 | 13 | 12 | 10 | 10 |
| 1100                       | 51 | 44 | 38 | 34 | 31 | 28 | 25 | 23 | 20 | 17 | 15 | 14 | 13 | 12 | 10 | 10 |
| 1000                       | 57 | 49 | 43 | 38 | 33 | 28 | 23 | 20 | 17 | 15 | 13 | 12 | 10 | 10 | 10 | 10 |
| 900                        | 55 | 48 | 41 | 33 | 28 | 23 | 20 | 17 | 15 | 13 | 12 | 10 | 10 | 10 | 10 | 10 |
| 800                        | 52 | 41 | 33 | 28 | 23 | 20 | 17 | 15 | 13 | 12 | 10 | 10 | 10 | 10 | 10 | 10 |
| 700                        | 52 | 41 | 33 | 28 | 23 | 20 | 17 | 15 | 13 | 12 | 10 | 10 | 10 | 10 | 10 | 10 |
| 600                        | 52 | 41 | 33 | 28 | 23 | 20 | 17 | 15 | 13 | 12 | 10 | 10 | 10 | 10 | 10 | 10 |
| 500                        | 52 | 41 | 33 | 28 | 23 | 20 | 17 | 15 | 13 | 12 | 10 | 10 | 10 | 10 | 10 | 10 |
| 400                        | 52 | 41 | 33 | 28 | 23 | 20 | 17 | 15 | 13 | 12 | 10 | 10 | 10 | 10 | 10 | 10 |
| 300                        | 52 | 41 | 33 | 28 | 23 | 20 | 17 | 15 | 13 | 12 | 10 | 10 | 10 | 10 | 10 | 10 |
| 200                        | 52 | 41 | 33 | 28 | 23 | 20 | 17 | 15 | 13 | 12 | 10 | 10 | 10 | 10 | 10 | 10 |
| 100                        | 52 | 41 | 33 | 28 | 23 | 20 | 17 | 15 | 13 | 12 | 10 | 10 | 10 | 10 | 10 | 10 |

anchura-width-largura

20 mm MAX. espesor vidrio-glass thickness-espessura vidro

# OS-150

Cod. OS150P10-MN7

MINI compás

Cod. OS150P10-ST7

STANDARD compás

Cod. OS150P10-LG7

LARGO long arm compasso longo

Ref. Color-Colour code-Código de Cor

7 Blanco/White/ Branco

8 Negro/Black/ Preto

9 Otros RAL/others/ outros

Acabados especiales en página 104

Other coatings see page 104

Outros lacagens ver página 104

Pack 1 un. 155x30x400 cms. 1,13Kgs.

Pack 10 un. 190x335x420 cms. 11,3Kgs.

